

3/8 NPT PIPE SIZE, 18 THREADS PER INCH,
0.41" THREAD ENGAGEMENT

3/8 NPT PIPE SIZE, 18 THREADS PER INCH,
0.41" THREAD ENGAGEMENT

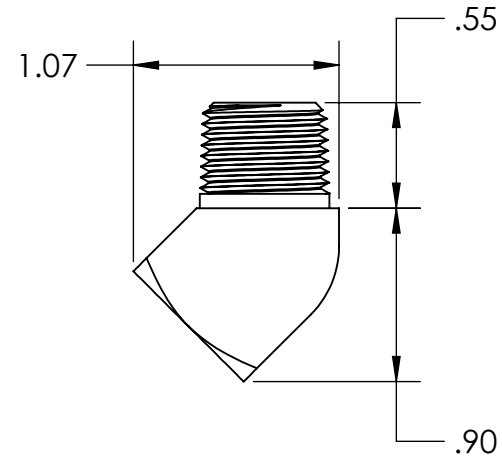
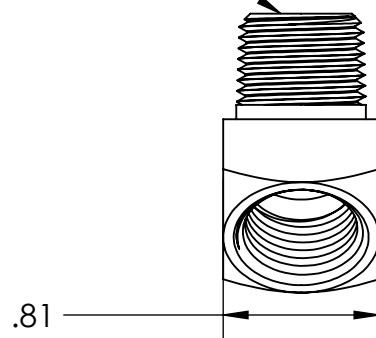

MATERIAL: BRASS

CONFIDENTIAL

Information contained in this document or drawing is confidential and proprietary to Polyconn. This document may not be reproduced without written permission from Polyconn. All rights of design, invention and copyright are reserved

TOLERANCES:
.xx = ±.01"
.xxx = ±.005"
.xxxx = ±.002"
FRAC. = ±1/64"
ANGLES = ±1/2°

UNLESS
OTHERWISE
NOTED

DRAWN BY:	DATE:
RSW	2/15/21
CHECKED BY:	DATE:
APPROVED BY:	DATE:

POLYCONN				
SIZE: A	TITLE ELBOW STREET 45° BRASS 3/8 NPT			REV: 01
DO NOT SCALE DRAWING	DIMENSIONS ARE IN INCHES UNLESS OTHERWISE NOTED	SCALE: 1:1	SHEET 1 OF 1	DWG NO. PC124B-6