

1/2 NPT PIPE SIZE, 14 THREADS PER INCH,
0.53" THREAD ENGAGEMENT

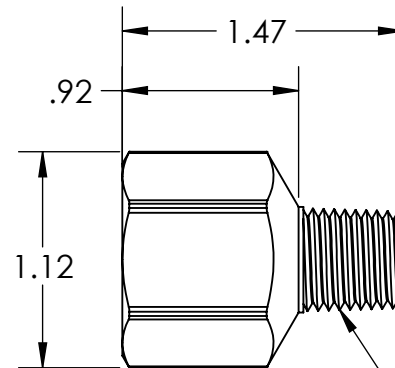
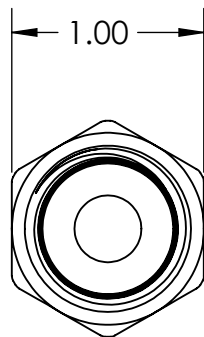

1/4 NPT PIPE SIZE, 18 THREADS PER INCH,
0.40" THREAD ENGAGEMENT

MATERIAL: BRASS

CONFIDENTIAL

Information contained in this document or drawing is confidential and proprietary to Polyconn. This document may not be reproduced without written permission from Polyconn. All rights of design, invention and copyright are reserved

TOLERANCES:
.xx = ±.01"
.xxx = ±.005"
.xxxx = ±.002"
FRAC. = ±1/64"
ANGLES = ±1/2°

UNLESS OTHERWISE NOTED

DRAWN BY:	DATE:
RSW	01/27/21
CHECKED BY:	DATE:
APPROVED BY:	DATE:

POLYCONN

SIZE:
A

TITLE
ADAPTOR BRASS 1/2 F X 1/4 M NPT

REV:
01

DO NOT SCALE DRAWING

DIMENSIONS ARE IN INCHES UNLESS OTHERWISE NOTED

SCALE:
1:1

SHEET
1 OF 1

DWG NO.

PC120B-84