

1/8 NPT PIPE SIZE, 27 THREADS PER INCH,  
0.26" THREAD ENGAGEMENT

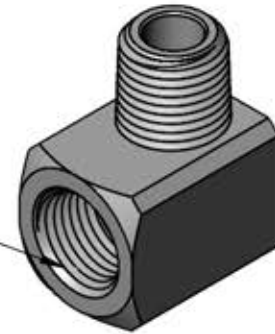

1/8 NPT PIPE SIZE, 27 THREADS PER INCH,  
0.26" THREAD ENGAGEMENT

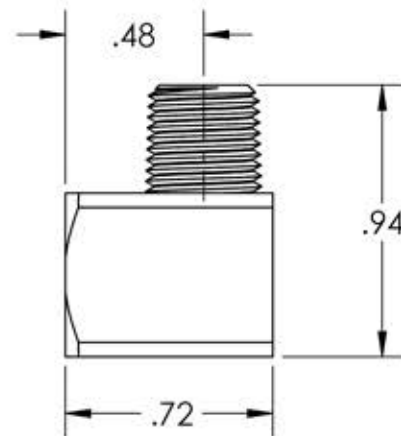
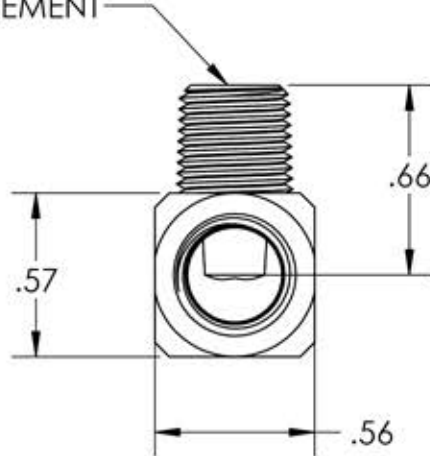

MATERIAL: BRASS

**CONFIDENTIAL**

Information contained in this document or drawing is confidential and proprietary to Polyconn. This document may not be reproduced without written permission from Polyconn. All rights of design, invention and copyright are reserved

TOLERANCES:  
.xx = ±.01"  
.xxx = ±.005"  
.xxxx = ±.002"  
FRAC. = ±1/64"  
ANGLES = ±1/2°

UNLESS  
OTHERWISE  
NOTED

DRAWN BY:	DATE:
RSW	01/04/21
CHECKED BY:	DATE:
APPROVED BY:	DATE:

POLYCONN

SIZE:  
A

TITLE

ELBOW STREET 90° BRASS 1/8 NPT

REV:  
01

DO NOT  
SCALE  
DRAWING

DIMENSIONS ARE IN  
INCHES UNLESS  
OTHERWISE NOTED

SCALE:  
3:2

SHEET  
1 OF 1

DWG NO.

PC116NB-2