

1/2 NPT PIPE SIZE, 14 THREADS PER INCH,
0.53" THREAD ENGAGEMENT

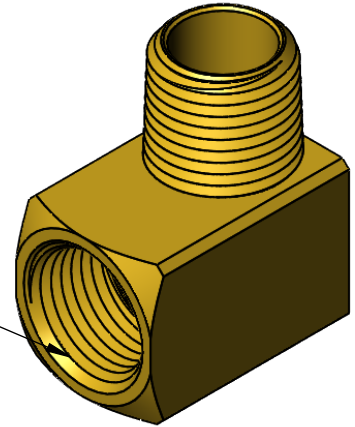

1/2 NPT PIPE SIZE, 14 THREADS PER INCH,
0.53" THREAD ENGAGEMENT

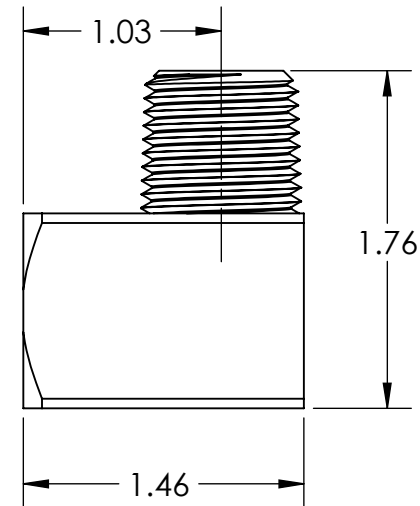
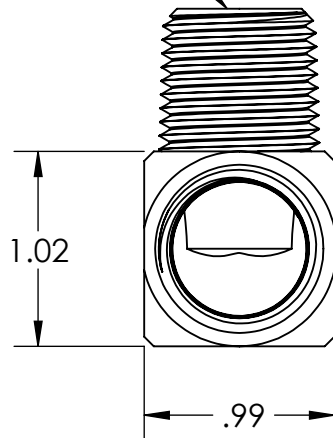

MATERIAL: BRASS

CONFIDENTIAL

Information contained in this document or drawing is confidential and proprietary to Polyconn. This document may not be reproduced without written permission from Polyconn. All rights of design, invention and copyright are reserved

TOLERANCES:
.xx = ±.01"
.xxx = ±.005"
.xxxx = ±.002"
FRAC. = ±1/64"
ANGLES = ±1/2°

UNLESS
OTHERWISE
NOTED

DRAWN BY:	DATE:
RSW	01/04/21
CHECKED BY:	DATE:
APPROVED BY:	DATE:

POLYCONN

SIZE:
A

TITLE
ELBOW STREET 90° BRASS 1/2 NPT

REV:
01

DO NOT
SCALE
DRAWING

DIMENSIONS ARE IN
INCHES UNLESS
OTHERWISE NOTED

SCALE:
1:1

SHEET
1 OF 1

DWG NO.
PC116B-8