

1/8 NPT PIPE SIZE, 27 THREADS PER INCH,
0.26" THREAD ENGAGEMENT

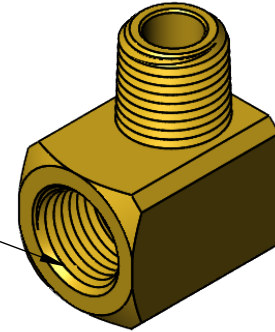

1/8 NPT PIPE SIZE, 27 THREADS PER INCH,
0.26" THREAD ENGAGEMENT

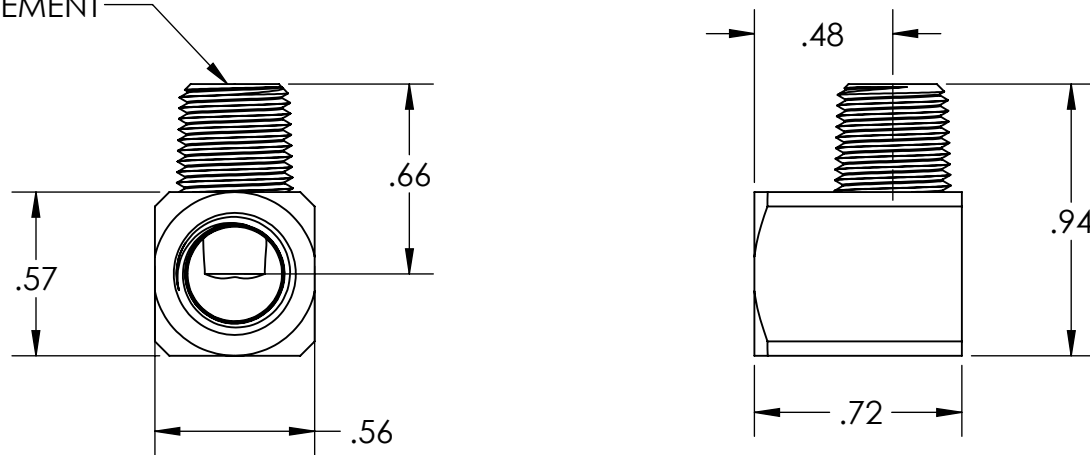

MATERIAL: BRASS

CONFIDENTIAL

Information contained in this document or drawing is confidential and proprietary to Polyconn. This document may not be reproduced without written permission from Polyconn. All rights of design, invention and copyright are reserved

TOLERANCES:
.xx = ±.01"
.xxx = ±.005"
.xxxx = ±.002"
FRAC. = ±1/64"
ANGLES = ±1/2°

UNLESS
OTHERWISE
NOTED

DRAWN BY:	DATE:
RSW	01/04/21
CHECKED BY:	DATE:
APPROVED BY:	DATE:

POLYCONN					
SIZE: A	TITLE ELBOW STREET 90° BRASS 1/8 NPT				REV: 01
DO NOT SCALE DRAWING	DIMENSIONS ARE IN INCHES UNLESS OTHERWISE NOTED	SCALE: 3:2	SHEET 1 OF 1	DWG NO. PC116B-2	