

1/4" NPT, 18 THREADS PER INCH,  
0.50" THREAD ENGAGEMENT

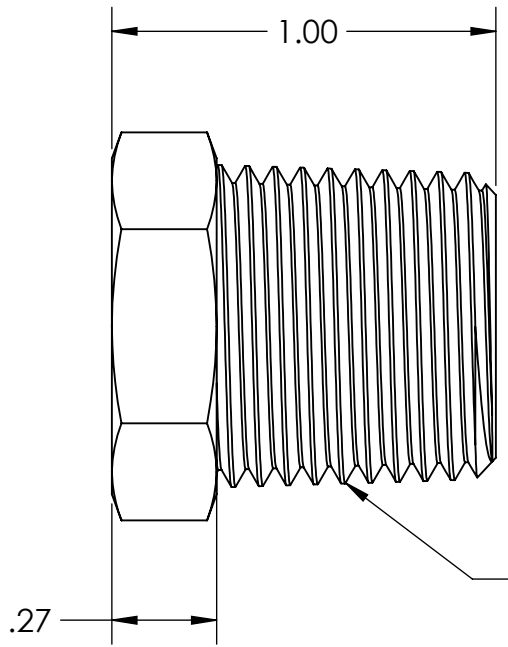
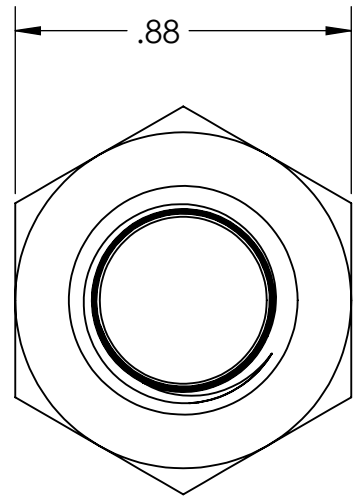

1/2" NPT, 14 THREADS PER INCH,  
0.71" THREAD ENGAGEMENT

MATERIAL: BRASS

**CONFIDENTIAL**

Information contained in this document or drawing is confidential and proprietary to Polyconn. This document may not be reproduced without written permission from Polyconn. All rights of design, invention and copyright are reserved

TOLERANCES:  
.xx = ±.01"  
.xxx = ±.005"  
.xxxx = ±.002"  
FRAC. = ±1/64"  
ANGLES = ±1/2°

UNLESS OTHERWISE NOTED

DRAWN BY:	DATE:
RSW	11/23/20
CHECKED BY:	DATE:
APPROVED BY:	DATE:

POLYCONN				
SIZE: A	TITLE HEX BUSHING BRASS 1/2 M X 1/4 F NPT			REV: 01
DO NOT SCALE DRAWING	DIMENSIONS ARE IN INCHES UNLESS OTHERWISE NOTED	SCALE: 2:1	SHEET 1 OF 1	DWG NO. PC110B-84