

1/2 NPT PIPE SIZE, 14 THREADS PER INCH,  
0.65" THREAD ENGAGEMENT

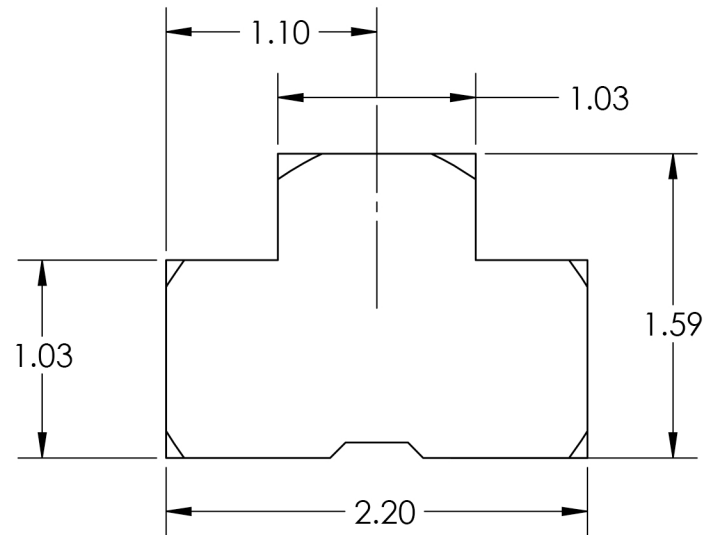
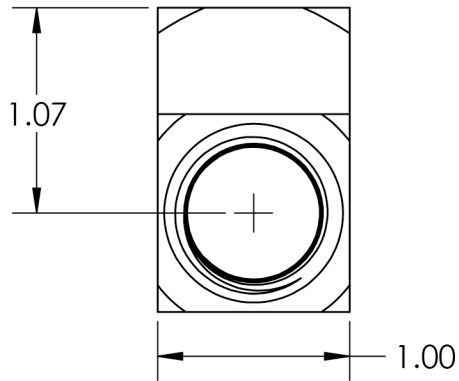

MATERIAL: BRASS

**CONFIDENTIAL**

Information contained in this document or drawing is confidential and proprietary to Polyconn. This document may not be reproduced without written permission from Polyconn. All rights of design, invention and copyright are reserved

TOLERANCES:  
.xx = ±.01"  
.xxx = ±.005"  
.xxxx = ±.002"  
FRAC. = ±1/64"  
ANGLES = ±1/2°

UNLESS  
OTHERWISE  
NOTED

DRAWN BY:	DATE:
RSW	08/04/20
CHECKED BY:	DATE:
APPROVED BY:	DATE:

POLYCONN				
SIZE: A	TITLE FEMALE TEE BRASS 1/2 NPT			REV: 01
DO NOT SCALE DRAWING	DIMENSIONS ARE IN INCHES UNLESS OTHERWISE NOTED	SCALE: 1:1	SHEET 1 OF 1	DWG NO. PC101NB-8